

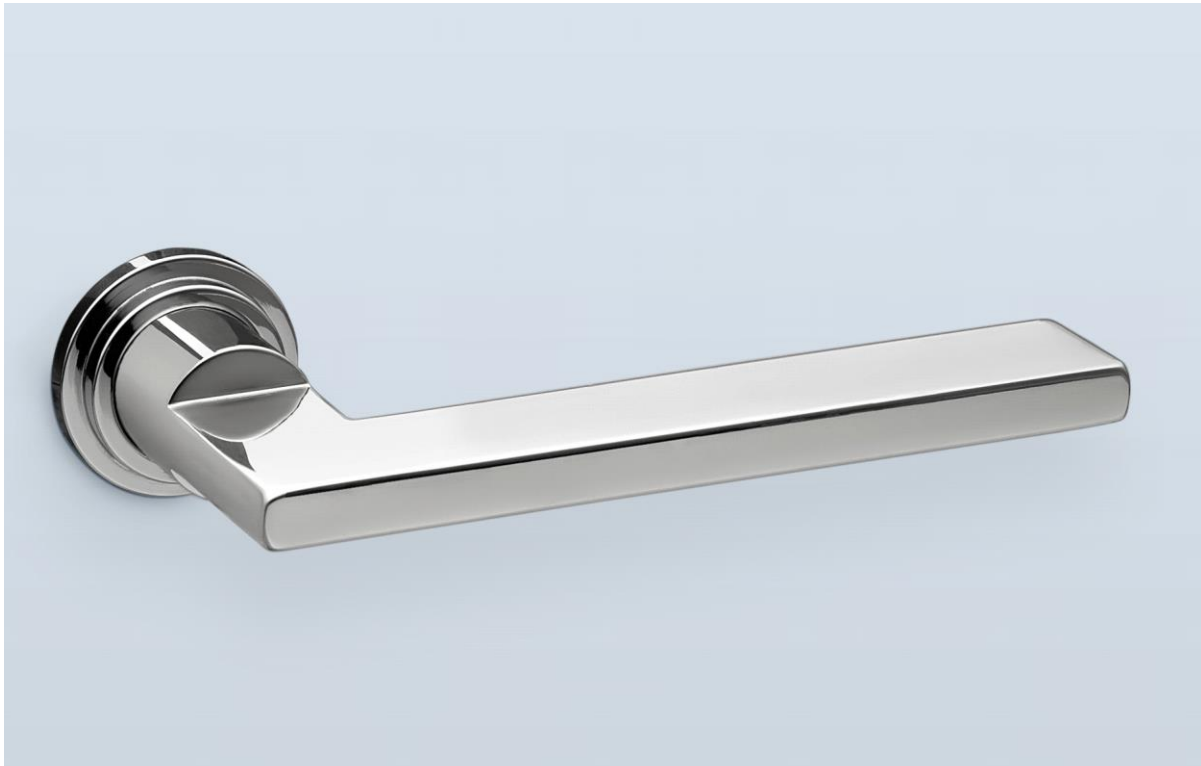

H . T H E O P H I L E

SINCE 1882



► **LEVER HT6240 - BACKPLATE HT3026**

H. Theophile's refinement of the HT6240 lever design draws on a review of the dozens of production variants of the Walter Gropius design circa 1930.

The 5" lever is shown here with a 1-3/8" round backplate. See HT3026 for additional backplate information.

See HT6014 for coordinating lever design.

LEVER LENGTH	BACKPLATE	PROJECTION
4-1/2" overall	1-3/8" diameter	2-1/2"
5" overall	1-3/8" diameter	2-1/2"
5-1/2" overall	1-3/8" diameter	2-1/2"

